

PTR030V

30 Volt DC radial leaded, PolyTron™ PTC devices



Product features

- PolyTron™ radial leaded thru-hole PTC device
- Maximum 30 volts
- Current ratings from 0.90 to 9.00 amps
- Fast time-to-trip
- Low resistance
- Halogen free, Lead free, RoHS compliant

Applications

- Medical equipment
- White goods
- Industrial power transmission
- Telecommunications
- Computers and peripherals
- Consumer and automotive electronics
- Rechargeable battery packs

Agency information

- cURus: Recognized Card: File E343021 (Ihold 0.9-9A)
- TUV File: J 50194729

Ordering information/ part number system

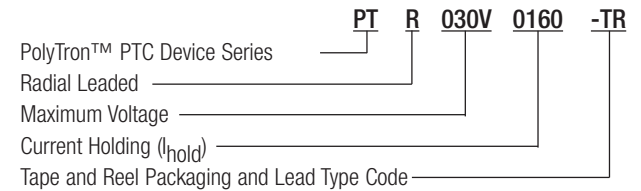

Lead Codes: TR & BK - Straight Leads, TR1 & BK1 - Kinked Leads

TR & TR1 On Reels

- 0.90-1.60A - 3000 devices
- 1.85-3.00A - 2000 devices
- 4.00-9.00A - 1000 devices

BK & BK1 In Poly Bags

- 0.90-1.35A - 1,000 devices
- 1.60-6.00A - 500 devices
- 7.00-9.00A - 250 devices

Specifications

| Catalog Number | V _{max} (Vdc) | I _{max} (Amps) | I _{hold} @23°C (Amps) | I _{trip} @23°C (Amps) | P _d Typ. (W) | Time to Trip (Max.) | | Resistance (Ω) | | | Agency Information | |
|----------------|------------------------|-------------------------|--------------------------------|--------------------------------|-------------------------|---------------------|-------|---------------------------|-------|----------------------------------|--------------------|-----|
| | | | | | | (Amps) | (Sec) | Initial (R _i) | | Post Trip (R _t) Max. | cURus | TUV |
| | | | | | | | | Min. | Max. | | | |
| PTR030V0090 | 30 | 40 | 0.90 | 1.80 | 0.6 | 4.50 | 5.90 | 0.070 | 0.120 | 0.22 | X | X |
| PTR030V0110 | 30 | 40 | 1.10 | 2.20 | 0.7 | 5.50 | 6.60 | 0.050 | 0.100 | 0.17 | X | X |
| PTR030V0135 | 30 | 40 | 1.35 | 2.70 | 0.8 | 6.75 | 7.30 | 0.040 | 0.080 | 0.13 | X | X |
| PTR030V0160 | 30 | 40 | 1.60 | 3.20 | 0.9 | 8.00 | 8.00 | 0.030 | 0.070 | 0.11 | X | X |
| PTR030V0185 | 30 | 40 | 1.85 | 3.70 | 1.0 | 9.25 | 8.70 | 0.030 | 0.060 | 0.09 | X | X |
| PTR030V0250 | 30 | 40 | 2.50 | 5.00 | 1.2 | 12.50 | 10.30 | 0.020 | 0.040 | 0.07 | X | X |
| PTR030V0300 | 30 | 40 | 3.00 | 6.00 | 2.0 | 15.00 | 10.80 | 0.020 | 0.050 | 0.08 | X | X |
| PTR030V0400 | 30 | 40 | 4.00 | 8.00 | 2.5 | 20.00 | 12.70 | 0.010 | 0.030 | 0.05 | X | X |
| PTR030V0500 | 30 | 40 | 5.00 | 10.00 | 3.0 | 25.00 | 14.50 | 0.010 | 0.030 | 0.05 | X | X |
| PTR030V0600 | 30 | 100 | 6.00 | 12.00 | 3.5 | 30.00 | 16.00 | 0.005 | 0.020 | 0.04 | X | X |
| PTR030V0700 | 30 | 100 | 7.00 | 14.00 | 3.8 | 35.00 | 17.50 | 0.005 | 0.020 | 0.03 | X | X |
| PTR030V0800 | 30 | 100 | 8.00 | 16.00 | 4.0 | 40.00 | 18.80 | 0.005 | 0.013 | 0.02 | X | X |
| PTR030V0900 | 30 | 100 | 9.00 | 18.00 | 4.2 | 45.00 | 20.00 | 0.005 | 0.010 | 0.02 | X | X |

Notes: I_{hold} – Hold current: Maximum current device will pass without interruption in 23°C still air.
 I_{trip} – Trip current: Minimum current that will switch the device from low resistance to high resistance in 23°C still air.
 V_{max}: Maximum continuous voltage device can withstand without damage at rated current.
 I_{max}: Maximum fault current device can withstand without damage at rated voltage.
 P_d: Power dissipated from device when in the tripped state in 23°C still air.
 R_i (min.): Minimum resistance of device as supplied at 23°C unless otherwise specified.
 R_i (max.): Maximum resistance of device as supplied at 23°C unless otherwise specified.
 R_t (max.): Maximum resistance of device when measured one hour post reflow (SMD) or one hour post trip (radial-leaded device) at 23°C unless otherwise specified.



Powering Business Worldwide

Dimensions - mm

| Part Number | A Max. | B Max Lead Type | | C | D Min. | E Max. | F | Figure/Lead Style | |
|-------------|--------|-----------------|-------------|----------|--------|--------|----------|-------------------|----------|
| | | Straight (-TR) | Kink (-TR1) | | | | | Straight TR | Kink TR1 |
| PTR030V0090 | 7.4 | 12.2 | 12.2 | 5.0±0.8 | 7.6 | 3.0 | 0.5±0.02 | 2 | 1 |
| PTR030V0110 | 7.4 | 14.2 | 14.2 | 5.0±0.8 | 7.6 | 3.0 | 0.5±0.02 | 2 | 1 |
| PTR030V0135 | 8.9 | 13.5 | 13.5 | 5.0±0.8 | 7.6 | 3.0 | 0.5±0.02 | 2 | 1 |
| PTR030V0160 | 8.9 | 15.2 | 15.2 | 5.0±0.8 | 7.6 | 3.0 | 0.5±0.02 | 2 | 1 |
| PTR030V0185 | 10.2 | 15.7 | 15.7 | 5.0±0.8 | 7.6 | 3.0 | 0.5±0.02 | 2 | 1 |
| PTR030V0250 | 11.4 | 18.3 | 20.5 | 5.0±0.8 | 7.6 | 3.0 | 0.5±0.02 | 2 | 1 |
| PTR030V0300 | 11.4 | 17.3 | 21.8 | 5.0±0.8 | 7.6 | 3.0 | 0.8±0.02 | 2 | 1 |
| PTR030V0400 | 14.0 | 20.1 | 24.6 | 5.0±0.8 | 7.6 | 3.0 | 0.8±0.02 | 2 | 1 |
| PTR030V0500 | 14.0 | 24.9 | 26.6 | 10.0±0.8 | 7.6 | 3.0 | 0.8±0.02 | 2 | 1 |
| PTR030V0600 | 16.5 | 24.9 | 29.4 | 10.0±0.8 | 7.6 | 3.0 | 0.8±0.02 | 2 | 1 |
| PTR030V0700 | 19.1 | 26.7 | 31.2 | 10.0±0.8 | 7.6 | 3.0 | 0.8±0.02 | 2 | 1 |
| PTR030V0800 | 21.6 | 29.2 | 33.7 | 10.0±0.8 | 7.6 | 3.0 | 0.8±0.02 | 2 | 1 |
| PTR030V0900 | 24.1 | 29.7 | 34.2 | 10.0±0.8 | 7.6 | 3.0 | 0.8±0.02 | 2 | 1 |

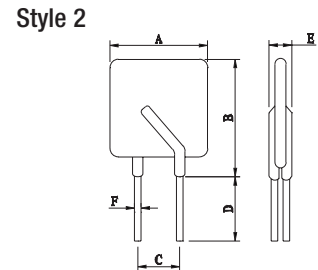
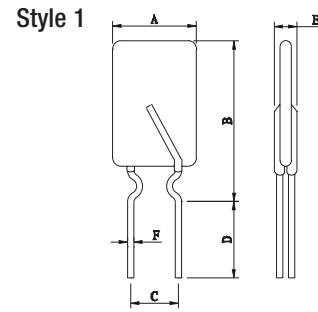

Packaging/Taping Specifications

| Description | IEC Mark | Dimension (mm) | Tolerance (mm) |
|---|----------------|----------------|----------------|
| Sprocket hole pitch | P ₀ | 12.7 | 0.3 |
| Ordinate to adjacent component lead PTR030V0090~PTR030V0300 | P ₁ | 3.6 | 1.0 |
| Ordinate to adjacent component lead PTR030V0400 | P ₁ | 3.45 | 1.0 |
| Ordinate to adjacent component lead PTR030V0500~PTR030V0900 | P ₁ | 7.3 | 1.0 |
| Device pitch PTR030V0090~PTR030V0300 | P | 12.7 | 1.0 |
| Device pitch PTR030V0400~PTR030V0900 | P | 25.4 | 1.0 |
| Lead spacing | C | * | -- |
| Carrier tape width | W | 18 | 1.0 |
| Top distance between tape edges | W ₀ | 3.0 | Max. |
| Hold-down tape width | W ₁ | 12 | 1.0 |
| Sprocket hole position | W ₂ | 9.0 | +0.75/-0.5 |
| Abscissa to top PTR030V0090~PTR030V0300 | H ₁ | 32.2 | Max. |
| Abscissa to top PTR030V0400~PTR030V0900 | H ₁ | 47.5 | Max. |
| Abscissa to plane (straight lead) | H | 18.0 | +2/-0 |
| Abscissa to plane (kinked lead) | H ₀ | 16.0 | ±0.5 |
| Sprocket hole diameter | D ₀ | 4 | ±0.2 |
| Lead protrusion | L ₁ | 1 | Max. |
| Tape thickness | t | 0.9 | Max. |
| Body lateral deviation | Δ _h | 0 | ±1.0 |
| Body tape plane deviation | Δ _p | 0 | ±0.13 |
| Reel width | W ₃ | 56 | Max. |
| Reel diameter | | 340 | ±10 |
| Arbor hole diameter | n ₀ | 31 | ±1 |
| Core diameter | n | 80 | Min. |

* See Dimensions table.

Figure 1 - PTR030V0090-PTR030V0400

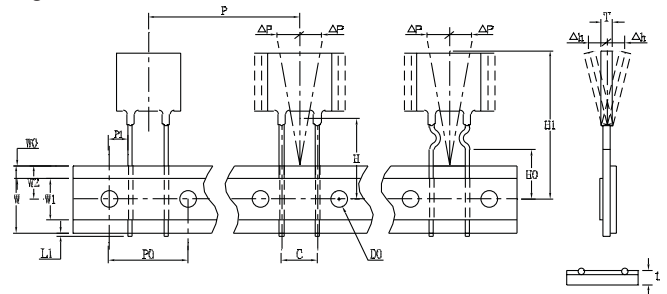
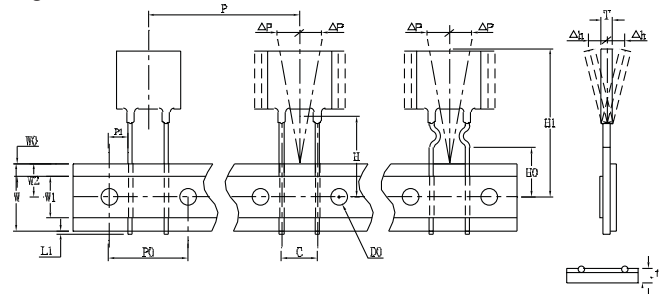
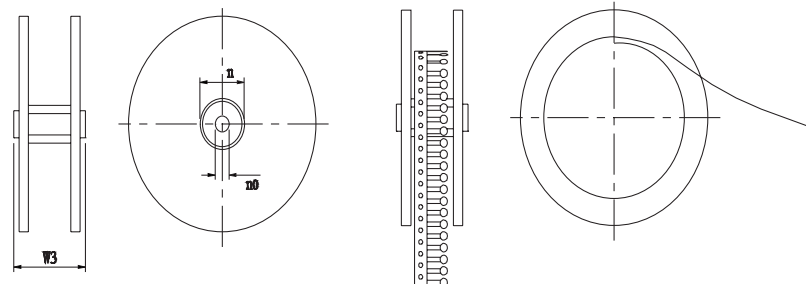

Figure 2 - PTR030V0500-PTR030V0900



Reel specification



Time-to-Trip Curves at 23°C

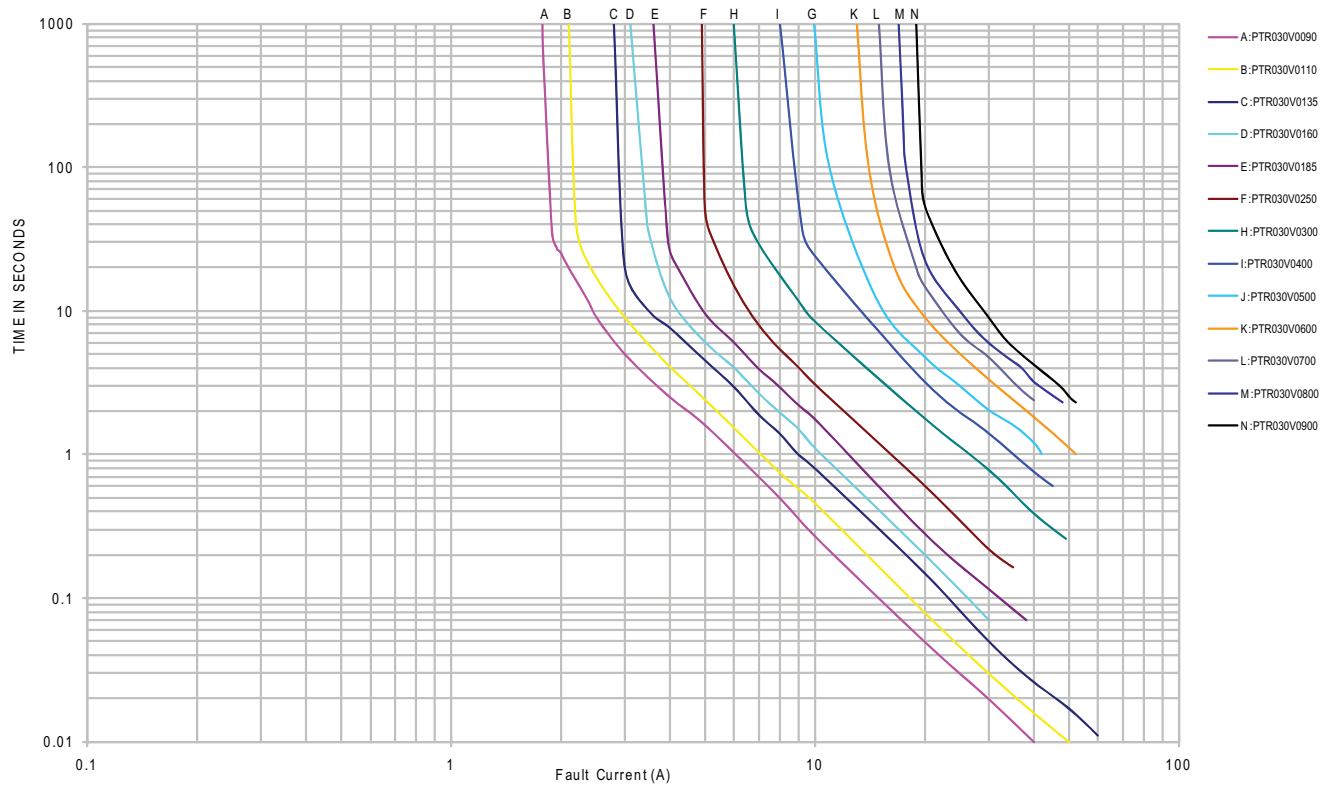

Thermal Derating Curve

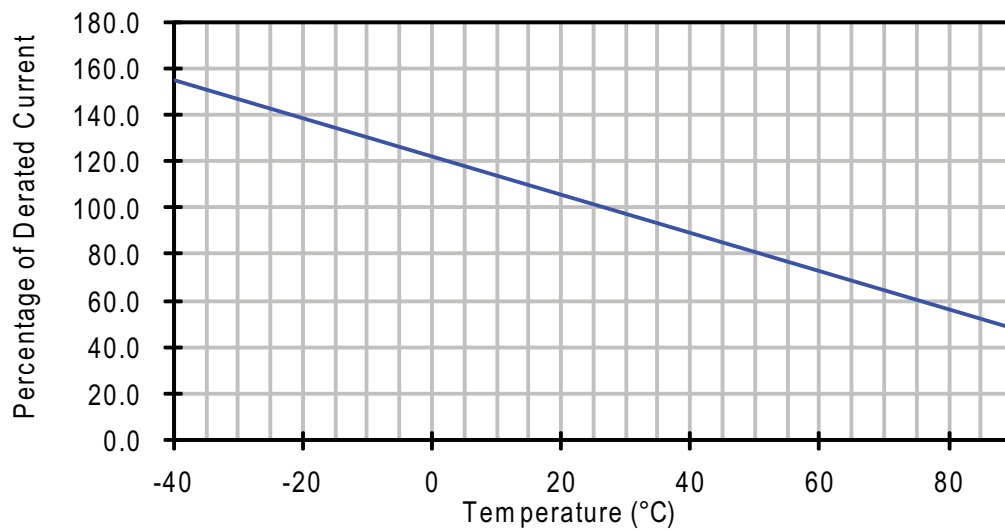

Recommended Wave Solder Profile.

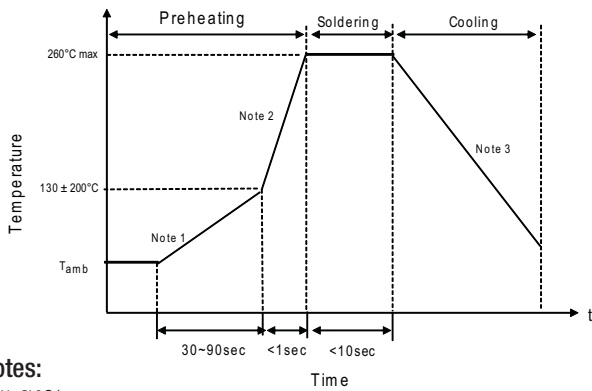

Notes:

1. (1-3)°C/sec
2. Approximately 200°C/sec
3. 5°C/sec Maximum

Recommended Reworking Conditions with Soldering Iron

- Soldering Iron Tip Temperature: 360°C max.
- Solder Time: 3 seconds max.
- Distance from Thermistor: 2mm min.

| Environmental Specifications | |
|--------------------------------|---|
| Characteristic | Value |
| Operating Temperature Range | -40°C to +85°C |
| Surface Temperature Trip State | 125°C max. |
| Thermal Shock | +85°C to -40°C , 10 cycles, 5% typical resistance change |
| Solvent Resistance | MIL-STD-202 Method 215, no change |
| Humidity Age Test | +85°C, 85% R.H., 1000 hours ±5% typical resistance change. Specified temperature (23°C ± 3°C) |
| Storage Temperature Range | -10°C to +40°C |
| Storage Duration | One year |
| Storage Relative Humidity | ≤75% |
| Storage Conditions | Keep away from corrosive atmosphere and sunlight |

Material Composition

- Lead material:
 - PTR030V0090-PTR030V0250 Tin-plated copper clad steel
 - PTR030V0300-PTR030V0900 Tin-plated copper
- Insulating material: Cured epoxy resin meeting UL 94V0 requirements

Life Support Policy: Eaton does not authorize the use of any of its products for use in life support devices or systems without the express written approval of an officer of the Company. Life support systems are devices which support or sustain life, and whose failure to perform, when properly used in accordance with instructions for use provided in the labeling, can be reasonably expected to result in significant injury to the user.

Eaton reserves the right, without notice, to change design or construction of any products and to discontinue or limit distribution of any products. Eaton also reserves the right to change or update, without notice, any technical information contained in this bulletin.

Eaton
Electronics Division
1000 Eaton Boulevard
Cleveland, OH 44122
United States
www.eaton.com/electronics

© 2017 Eaton
All Rights Reserved
Printed in USA
Publication No. 4400 BU-SB11019
June 2017